

# Gear Edge 7 Panel

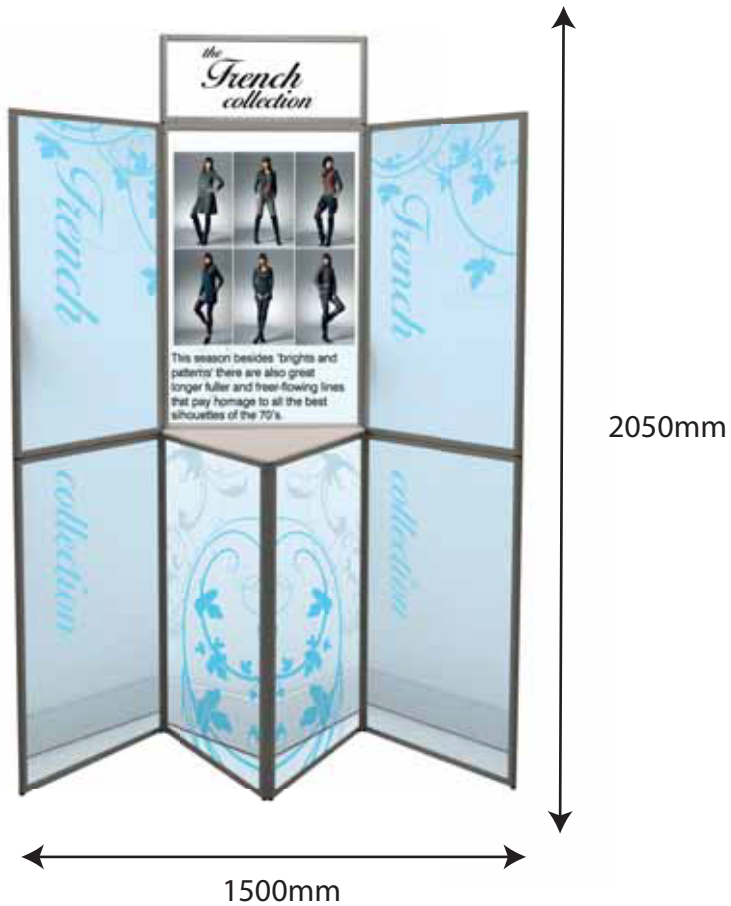

Infill panel size: 879 x 568mm  
Visible panel size: 867 x 556mm  
Header Panel  
Infill panel size: 229 x 568mm  
Visible panel size: 217 x 556mm  
Max thickness: 6mm



10.80kg with out infill  
19.50kg with infill

**1**

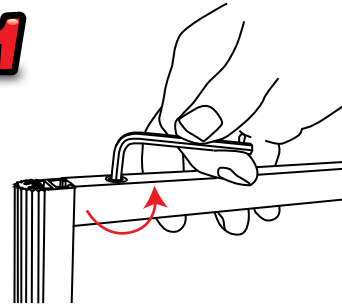

**2**

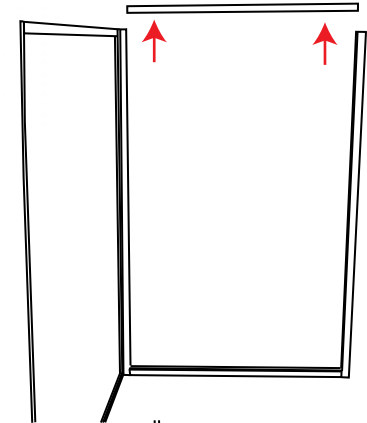

**3**

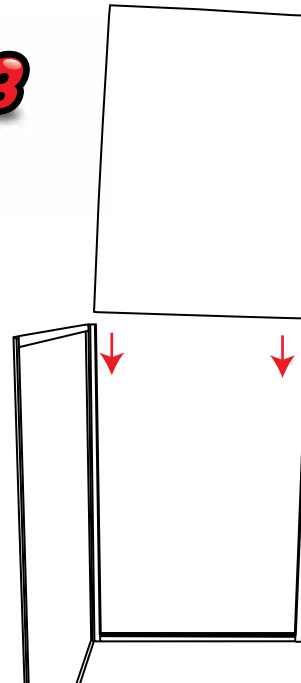

**4**

Graphic/Panel

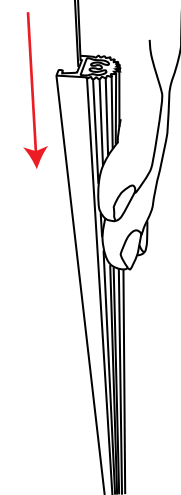

# Gear Edge 7 Panel

**5**

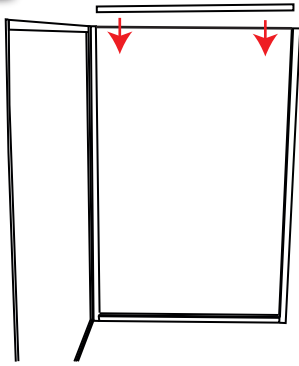

**6**

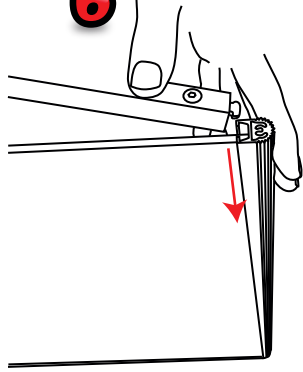

**7**

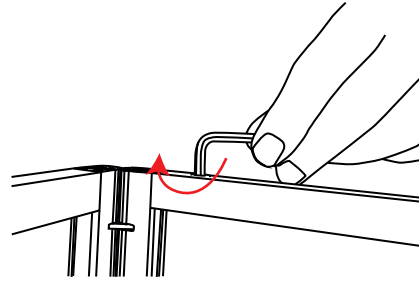

**8**

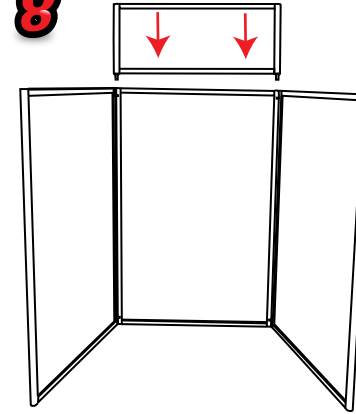

**9**

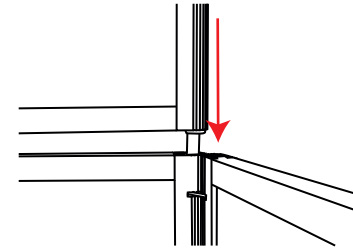

**10**

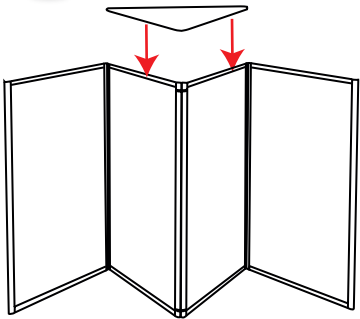

**11**

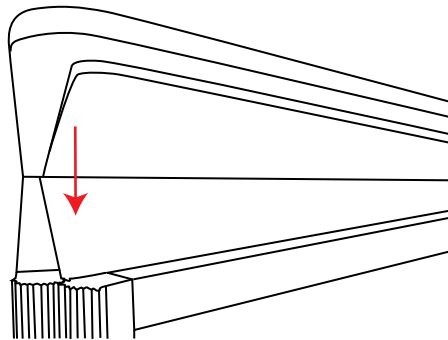

**12**

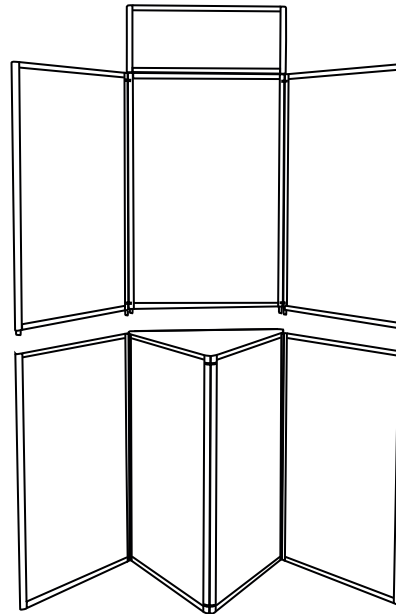

**13**

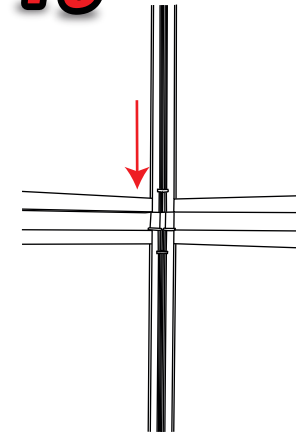

Included in your kit is a pack of 60 x 50mm soft hollow plastic packers which if required, can be inserted into the inner frame channel filling the void behind your graphic panel

Important- Please be careful not to place fingers near the gear edge mechanism

Gear Edge 7 Panel

**Installation**