

Tapered Circle Hanging Structure

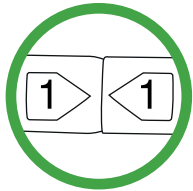

1

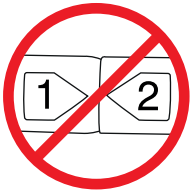
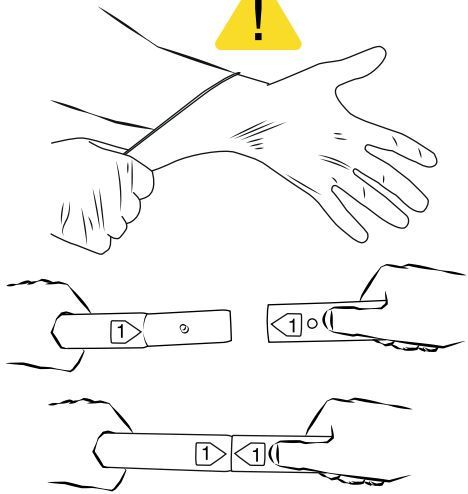
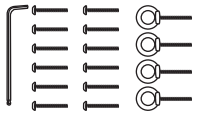
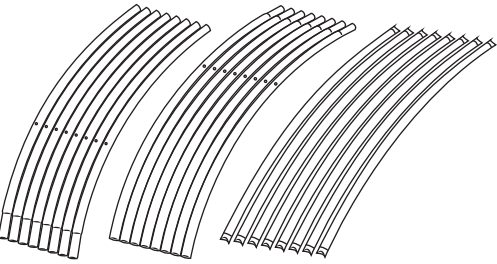
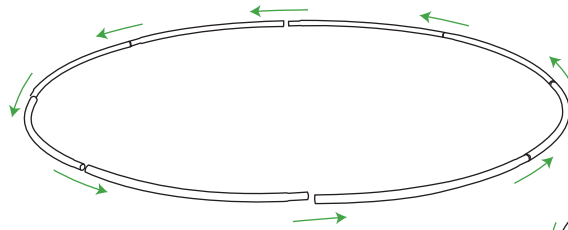

2

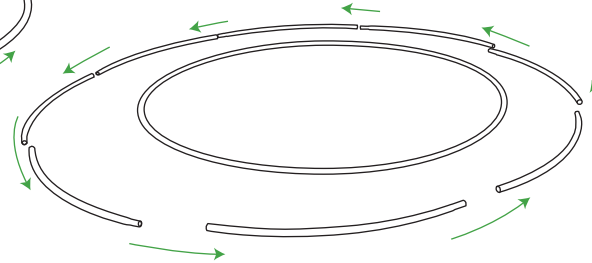

3

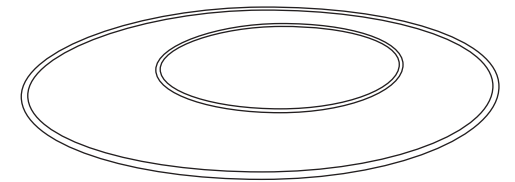

4

Important Note: Numbers face inward to align poles with screws

5

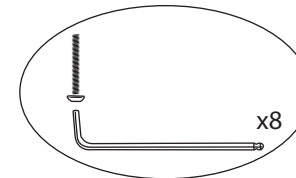
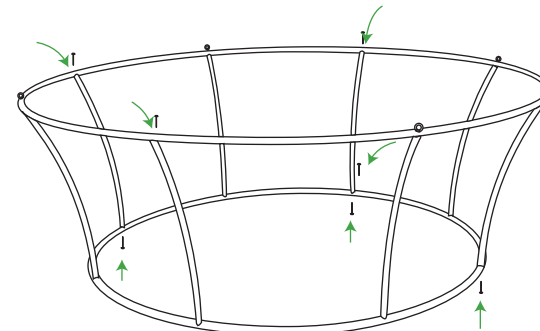
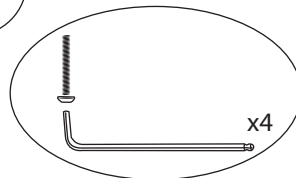
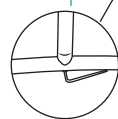
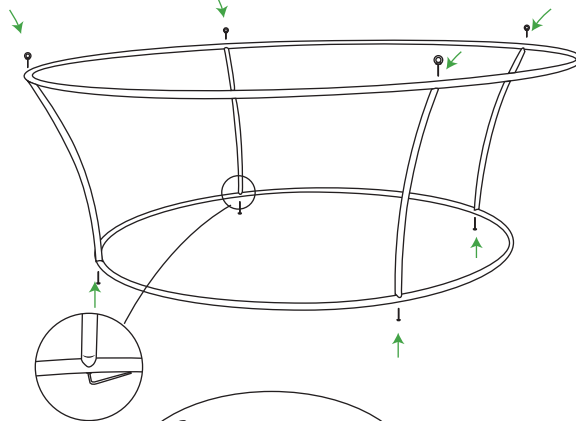

Important note: These instructions are based on assembling the 3m version. Other size kits will have slightly different configurations of poles but can still be assembled in the same way.

Tapered Circle Hanging Structure



Attaching Graphic

1

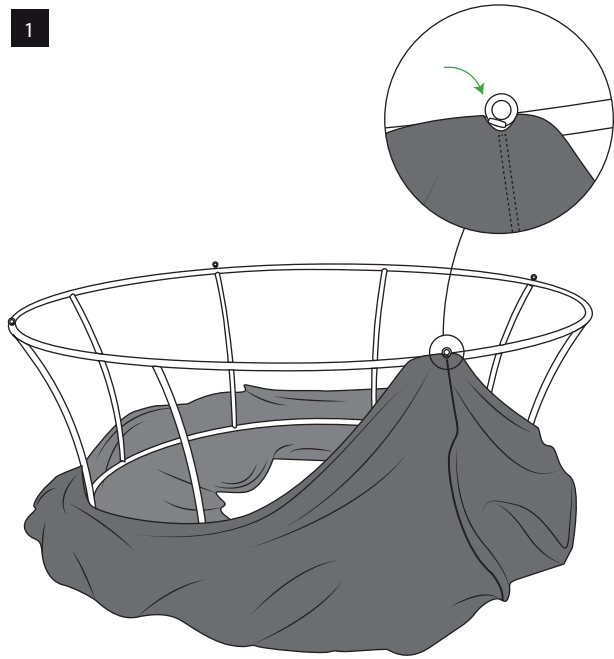

2

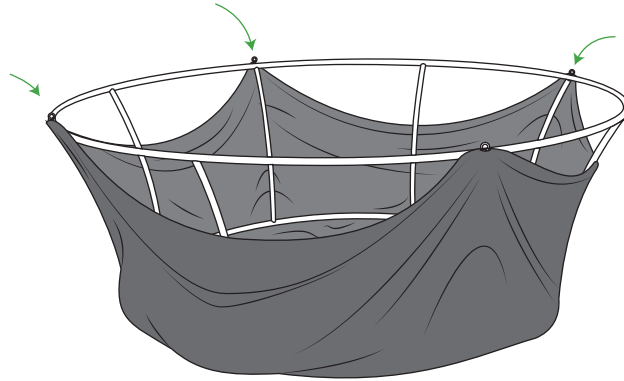

3

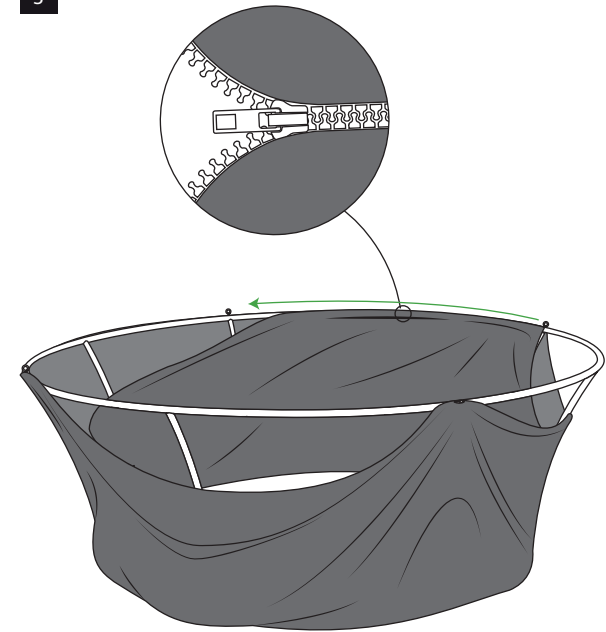

4

