



# Counter Assembly





**DEMO CENTER TEMPLATE @ 100%**

- Graphic image/logo safe site area
- Non printable area
- Allow for fold on top side of panel 1mm gap

**HEADER**

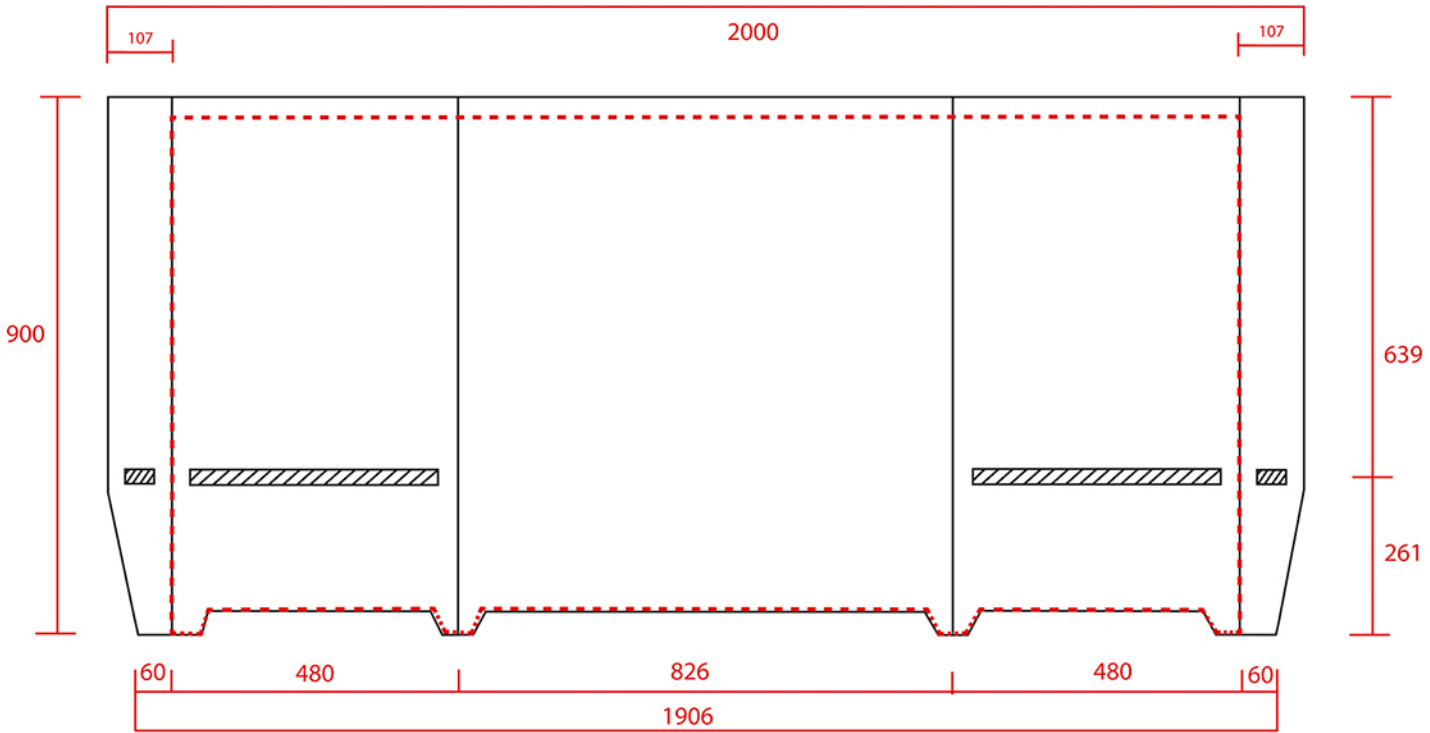
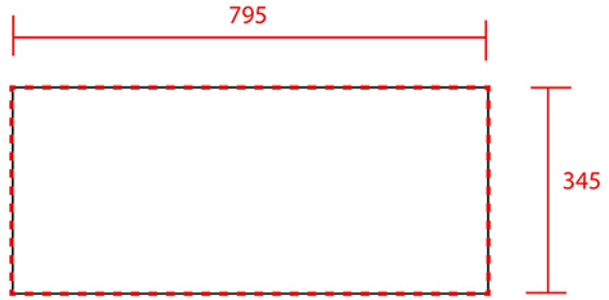

SIDE PANEL

FRONT SECTION

SIDE PANEL



# Demo Center

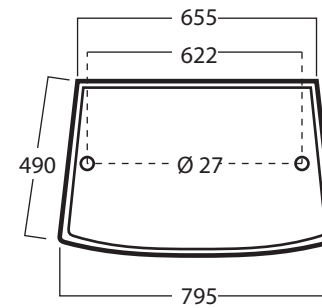

Top

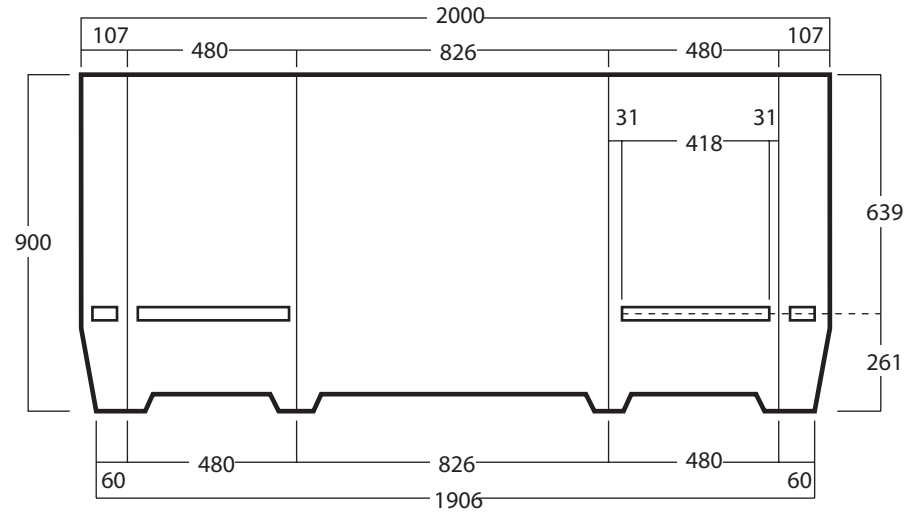

Graphic Size for Unit  
Allow 37.5mm for top

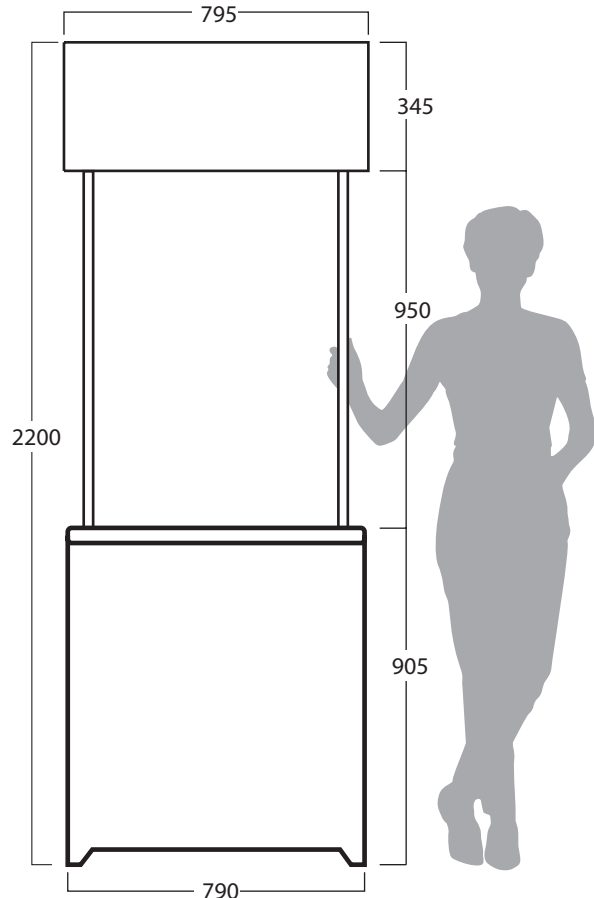

Unit and Header

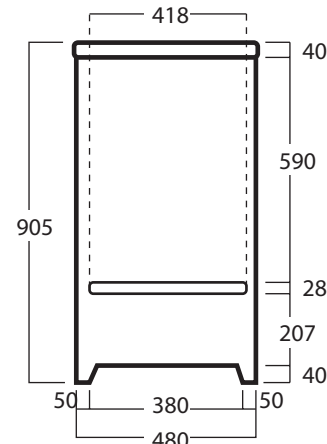

Side

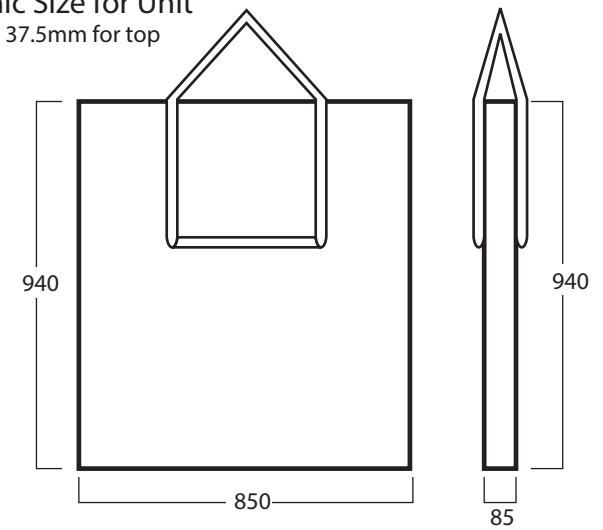

Carry Bag