



Pro unit with internal shelf



Standard unit (no shelf)

Data Pod is a stylish workstation constructed from MDF with high quality finish thermoformed laminated tops.

features & benefits

- Internal shelf available with Pro unit only
- Constructed from composite materials and flexible MDF tambour
- Flat packed, easy to transport and quick to assemble
- Allen key supplied
- Load bearing up to 75kgs approx
- Tops are available in Birch, Black or Silver thermoformed finishes
- Choice of Luxury Foam Backed Loop Nylon, Front Runner or Prelude fabric wrap colours
- Beech and Aluminium tambour wraps also available
- AB138B and AB120A carry bags included
- Standard LCD bracket included

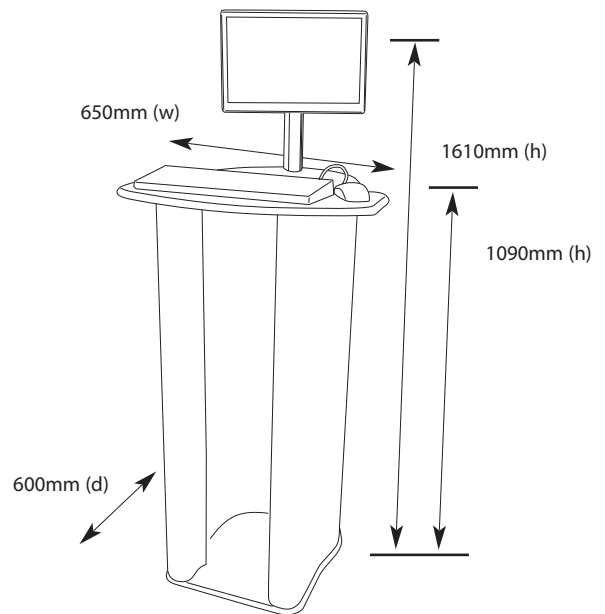

hardware specifications

Overall size (h) x (w) x (d):
 1610mm x 650mm x 600mm
 Weight:
 19kg
 Optional internal shelf size (w) x (d):
 280mm x 560mm
 Useable internal shelf height:
 210mm deep

wrap specifications

Tambour Wrap dimensions (h) x (w):
 1059mm x 1740mm
 Including internal shelf:
 840mm x 1740mm
 210mm x 1740mm
 If applying a graphic to the wrap, an allowance should be made to its size to accommodate material type, thickness etc.

additional info



Assembly Instructions

Data Pod Pro assembly



Pro Kit includes: Top (A), base (B), internal shelf (C), large wrap, small wrap, monitor bracket, Linear post, allen keys

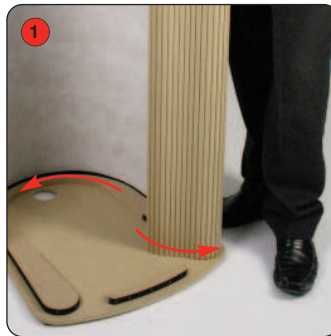

Place the base on the floor and attach the large wrap around the base onto the hook and loop as shown.



Once the wrap is in position, lower the internal shelf onto the top of the wrap, following the shape of the mounts.

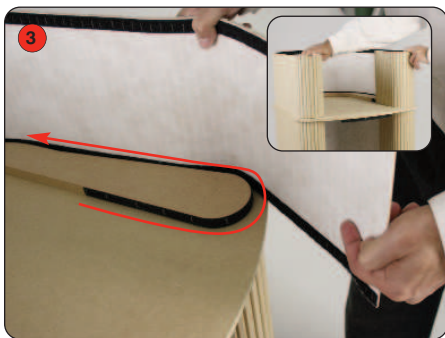

Take the smaller wrap and attach to the top of the shelf, following the shape of the hook and loop mount.



Lower the top onto the smaller wrap, inserting the mount into the shape securely.

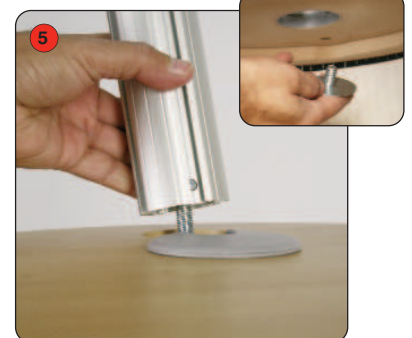

Insert cable management port. Take the screw and washer and push through the hole in the top, fixing into the Linear post.

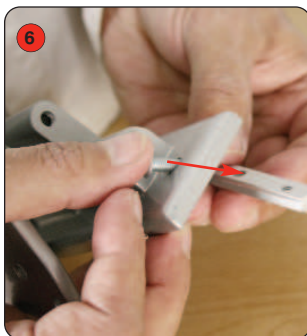

Take the monitor bracket and screw loosely into the linear slider.

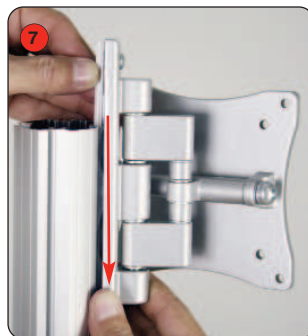

Slide the completed bracket down the post into position and tighten screws to secure.

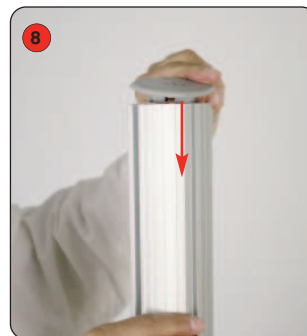

Complete unit by attaching Linear post top into place.



NB - For the standard unit without an internal shelf, miss out steps 2 and 3.