



Mercury is a stylish workstation or greeting counter constructed from MDF with high quality finish thermoformed laminated tops.

features & benefits

- Constructed from composite materials and flexible MDF tambour
- Flat packed, easy to transport and quick to assemble
- Allen key supplied
- Load bearing up to 75kgs

Tops are available in Birch, Black or Silver thermoformed finishes

- Choice of Luxury Foam Backed Loop Nylon, Front Runner or Prelude fabric wrap colours
- Shelf on the Mercury Pro
- Open or closed back available
- Beech and Aluminium tambour wraps also available
- Cable management port included



Closed back - fabric, aluminium or beech tambour

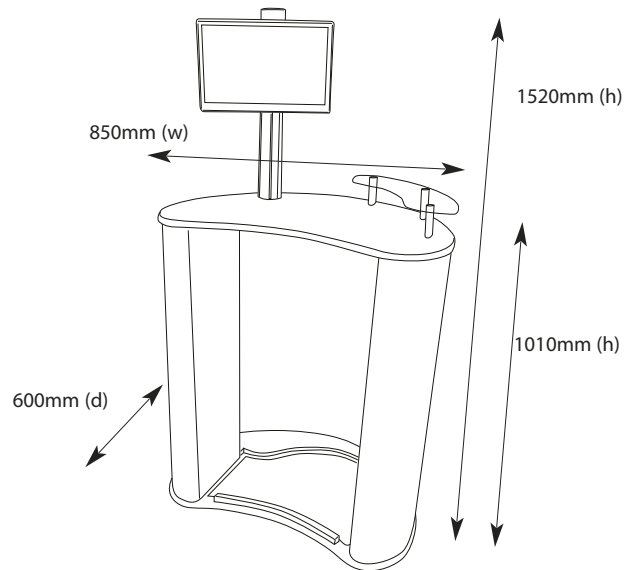

hardware specifications	wrap specifications	additional info
Overall size (h) x (w) x (d): 1520mm (top of LCD post) x 850mm x 600mm Weight: 19kg Optional internal shelf size: 180mm Deep	Tambour Wrap dimensions (h) x (w): 970mm x 2320mm If applying a graphic to the wrap, an allowance should be made to its size to accommodate material type, thickness etc.	Recommended accessories: Std 1040 x 740 x 200 bag (AB115B).

Assembly Instructions

Mercury assembly

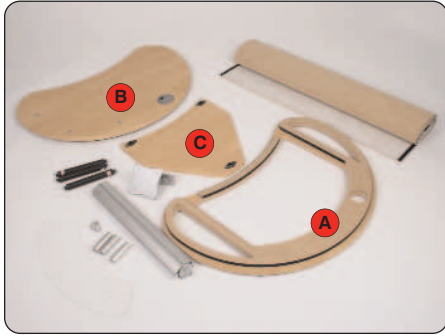

Pro Kit includes: Base (A), top (B), internal shelf (C), 3 x Twist & Lock posts, wrap, Linear post, monitor bracket, acrylic top shelf, 3 x stand-offs, 3 x screws, fixings, 2 x Allen keys



1 Place the base on the floor and feed the wrap around the hook and loop mounted area.



2 Take the top and lower onto the wrap, inserting the hook and loop mount into the wrap securely.



3 Take the internal shelf and twist in the 3 Twist & Lock posts in the slots provided.



4 Lift the shelf into the unit and twist in each post to secure the shelf.

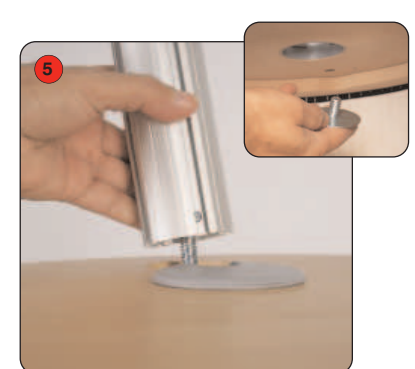

5 Fasten the linear post to the top with the screw and washer

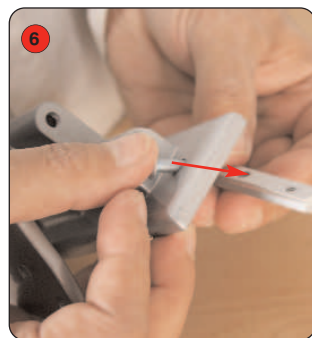

6 Take the monitor bracket and screw loosely into the linear slider.

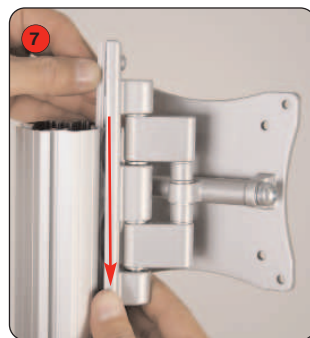

7 Slide the assembled bracket down the post into position and tighten screws to secure.



8 Complete unit by attaching Linear post top and cable management port into place.

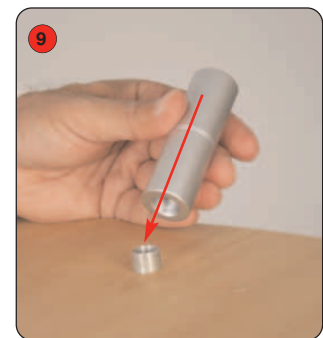

9 Take each stand-off and screw onto the top of each fixing supplied.

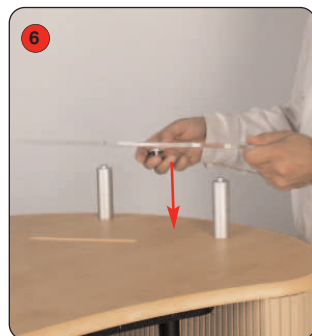

6 Lower the acrylic shelf onto the top of the 3 standoffs.



7 Secure into position by screwing in the tops of each stand-off.

NB - For the standard unit without an internal shelf, miss out steps 3 and 4.

